

GENERAL INFORMATION

TH-2006(TX)

This thermostat commands heating-system to operate with two pre-selected temperature setpoint (COMFORT & ECONOMY). Each of 7-day is spread into 48 time-zone, provides great convenience to users to select desired temperature setting to the needs in daily life.

This large LCD thermostat is produced with self-explanatory programming design, backlight function incorporated to bring great convenience to users upon programming this thermostat in dim surrounding.

Also an unique LED reflector(Auto) is built to illuminate operate mode to avoid confusion in programming this thermostat.

For easy operate in actual application, this unit has STAND-BY  function provides quick & simple way to temporary cut off heating when it is not required.



Useful advices for installation



- In the main occupancy room or reference room
- The place of installation should be chosen so that sensor can capture the room temperature as accurately as possible, without being affected by direct solar radiation or other heating or cooling source.
- Mounting height should be approximate 1.5 meters above the floor.
- The unit can be fitted to most commercially available recessed conduit boxes or directly on the wall.

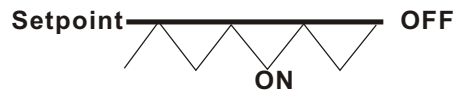

Technical data

- EEPROM memory backup
- Temperature display range: 0 ~ 50°C
- Temperature control range: 5 ~ 35°C
- Temperature sampling rate: 1 minute
- Switching differential(Hysteresis): 0.5°C.



- Temperature adjusting scale: 1°C
- Temperature display scale: 0.1°C
- All 7-Day independently programmed
- 24-Hour- format, spread into 48 time programming zones
- Solar  & Lunar  symbols represents "Comfort" & "Economy" temperature setting, easy to programming
- Battery-low indication(for Battery model only)
- Relay output compulsory shut-off, after 5-time Battery-low warning.
- Battery replacement frequency: once every 12 months.
- Output rating: 10 AMP / 250 Vac, Voltage-free, SPDT.
- Dimension: 138 x 86 x 29.6 mm

INSTALLATION AND MAINTENANCE

DANGER

Electric Shock Or Fire Hazard

READ ALL WIRE SIZING, VOLTAGE REQUIREMENT AND SAFETY DATA AVOID PROPERTY DAMAGE AND PERSONAL INJURY

Guide to batteries replacement & Wiring

Under normal operation, users requires to replace batteries once every year, to avoid unnecessary damage which might occur while changing batteries or newly installation of this thermostat, it's recommended to follow up with description stated below.

Assisting tool required: "—" Flat-head screw driver

To open top case to replace batteries

1. Open top plastic case from "closure" from here
2. One hand holds thermostat another hand holds flat-head screw driver.
3. Gently position head of screw-driver into aperture.
4. Gently lift tail of screw-driver upward, to open "closure".
5. Use two hands to separate top and bottom plastic cases.
6. Replacing batteries from here.

Close top case after batteries replacement or wiring works

1. Positioning two closure-stud at top-case to 2 closure-slot at bottom-case.
2. Close.
3. Press to firmly close thermostat.

Proposed application(wiring)

Assisting tool required: "+" head screw-driver

1. Slacken screw on bottom plastic case.

2. Connect output terminals to heating system in accordance with instruction printed on protective cover. (Proposed application described below)

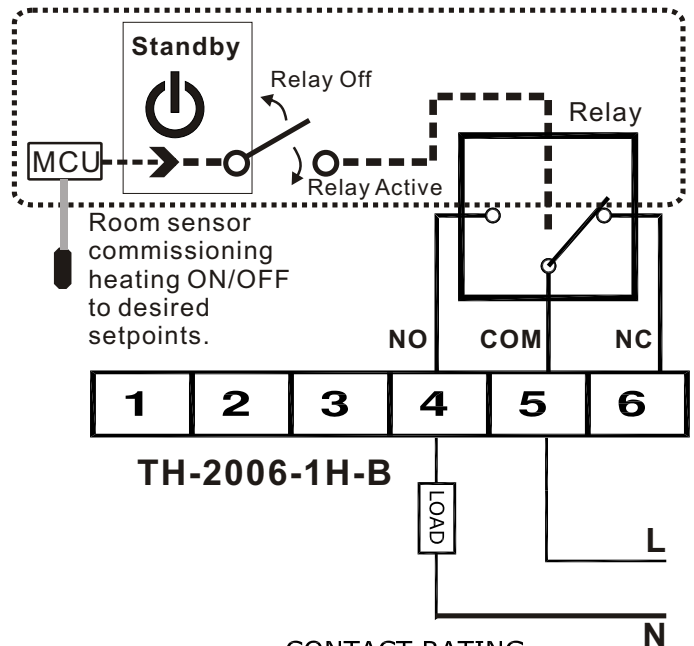

CONTACT RATING:
10 A/250Vac
Volt-free

PROGRAMMING INSTRUCTIONS # 1

Description to function keys

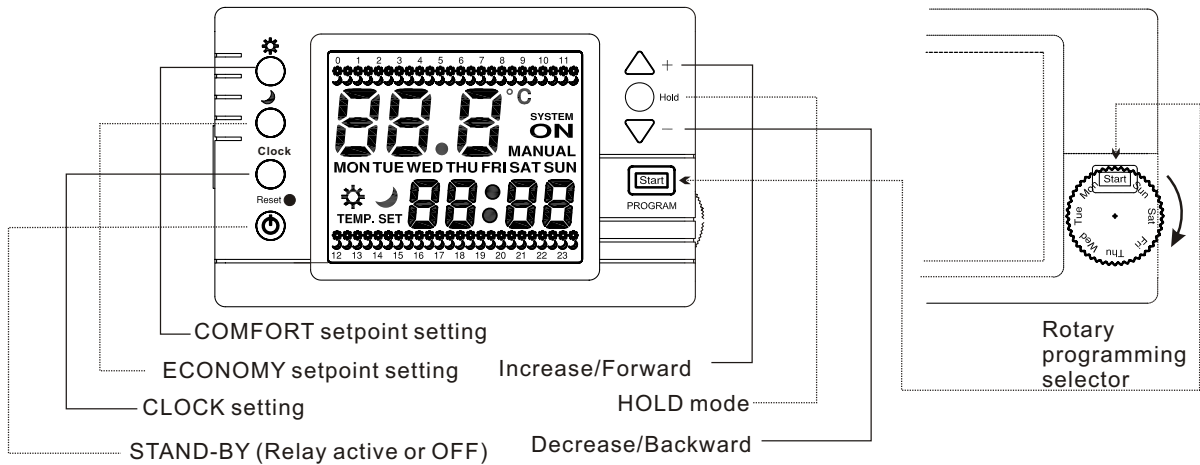

A. Adjusting CLOCK to accurate time before programming thermostat

1. Spin Rotary programming selector to "START"
2. Press to enter clock setting.
3. Press + or - to select accurate Day of Week.
4. Press again to select accurate Hour of Day.
5. Press + or - to select.
6. Repeat procedure above to complete CLOCK setting.
7. Wait 5 seconds after CLOCK setting completed, thermostat shall automatic memorize setting.

B. Set COMFORT (⚙️) & ECONOMY (🌙) setpoint

1. Spin rotary selector to "START"
2. Press to enter COMFORT setpoint selection.
Press again , symbol ⚙️ shall be flashing on LCD.
3. Press + or - to set desired COMFORT setpoint.
4. Press to enter ECONOMY setpoint selection.
Selecting setpoint with the same procedure as described above.
5. Wait 5 seconds after both COMFORT & ECONOMY setpoints selection is done, thermostat shall automatic execute.

C. Setting COMFORT ⚙️ & ECONOMY 🌙 setpoint for each of independent time-zone in Day of Week

(*Wednesday 05:00 chosen for graphic example)

1. Spin rotary selector to desired Day of Week.
2. Follow the guide by flashing shown on LCD.
3. Press or to alter setting between ⚙️ and 🌙 on LCD.
4. Press + or - to select each independent time-zone. LCD shall indicate each time-zone by digital numbers and flashing on LCD throughout entire programming process.
5. After completed programming all 7-day, spin rotary selector to "START". Thermostat shall begin commissioning heating-system to operate in accordance with programmed commands.

During programming this section, if by any reason users stop procedure more than 1 minutes, a "Err" symbol shall show on LCD (as graphic shown below) and Relay shall be temporary shut-off, until programming completed.

To spin rotary selector away its last position and then switch back, the programming shall resume, "Err" symbol shall vanish



Reminder

PROGRAMMING INSTRUCTIONS # 2

Programming default

☀ = 21°C 🌙 = 16°C

Pre-programmed Mon ~ Fri

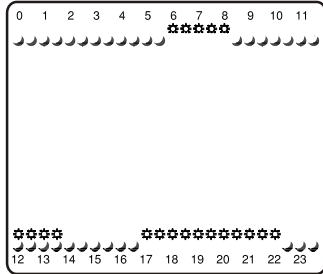

Sat ~ Sun

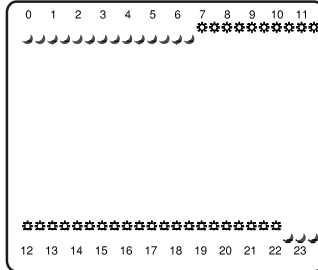

D. Override function

1. HOLD (Permanent override)

■ Spin rotary selector to "START".

■ Press Hold to enter this

override mode. "Temp Set" & "HOLD" shall be shown on LCD.

■ Press + or - to adjust

"HOLD" temperature setpoint.

■ Wait 10 seconds, thermostat shall automatic operate this permanent override.

■ Press Hold again, shall deactivate

HOLD.

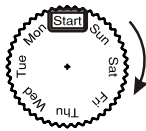

2. MANUAL (Temporary override)

■ Spin rotary selector to "START"

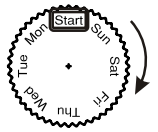

■ Press + or -

Current (comfort) or (economy) setpoint.

■ Press + or -

to change or setpoint.

■ LCD shall be flashing 8 seconds after setpoints was changed, and starts to operate temporary override.

*If **MANUAL** is operating in programming zones of , when it reaches programming-zone of this temporary override shall be automatic stopped and the programming resumes its commissioning the heating system. Vice versus.

When **MANUAL** is operating, symbols either or in programming-zone shall temporary disappear.

■ Users can deactivate this temporary override by spinning rotary selector away from "START" and then spin it back to "START". The programming shall resume commanding heating system.

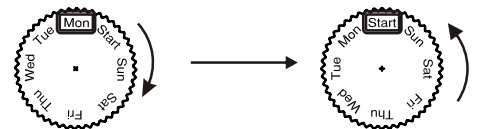

RF Address Code Setting

On the back of the transmitter circuit board.
If there is another RV-0356 receiver unit nearby, e.g in the next house, the receiver may be fault triggered by the other transmitter. You may select different RF address code to prevent this. Receiver can only response to RF coding with the same address code setting as its own address code.

On the back of the transmitter circuit board



On the back of the receiver circuit board.

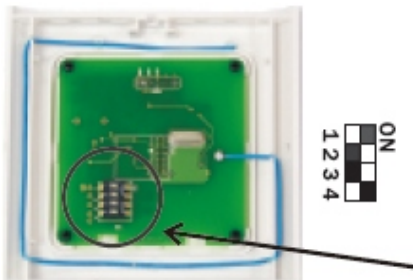

Set the selection the same way on both frequency selection switches.