

## CC908XWHB-7-DF1 Waterline Master Control Controller

CC908XWHB-7-DF1 waterline master controller can use as on off the thermo actuator for adjust the room temperature application.

### SPECIFICATION

Power source .....	2 AA size 1.5V alkaline battery
Wireless frequency band.....	868MHZ (FSK)
Wireless transmitter range.....	100m in the open air
Room temperature setting range .....	5°C~50°C or 41°F~123°F
Accuracy.....	0.5°C or 1°F
Ambient temperature-operation.....	0°C~+50°C (32°F~122°F)
Ambient temperature-transport.....	-10°C~+60°C (14°F~140°F)
Dimensions.....	115×90×32mm

### KEYBOARD, DISPLAY AND SWITCH DESCRIPTION

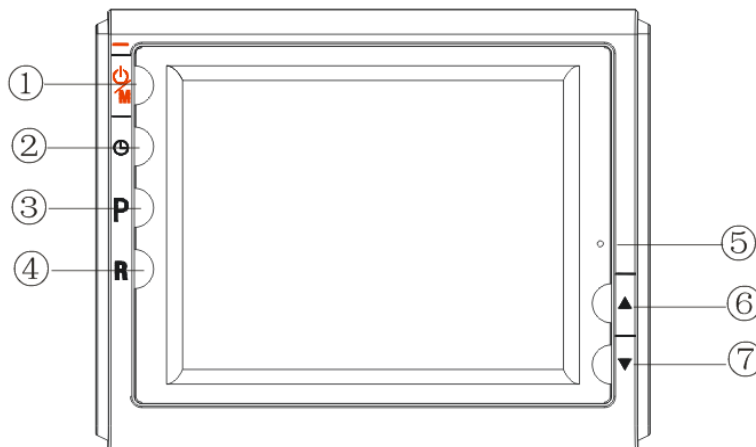

Button and Functional description:

- ① Power on/ anti-freezing /off button;
- ② Time setting button; At starting shortly press ② button enter setting the minute, press add and subtract key, adjust the minute, press ④ button to confirm and exit; then shortly press ② button enter setting the date, press add and subtract key, adjust the week, press ④ button to confirm and exit.
- ③ Program Setting button; at starting up and program running state(programming mode) shortly press button ③ enter the program and set the date, then press button ③ enter programming time, press button ③ enter programming temperature; at starting up and program running state long press button ③ more than 3 seconds enter keeping running mode forever; at shutdown state long press button ③ more than 3 seconds enter implied parameters setting the first item, then press button ③ enter implied parameters setting the next item.
- ④ Confirm/Exit button; At setting state shortly press button ④ is all setting confirmation and exit forever keeping mode, or at temporarily keeping mode shortly press button ④ to exit and return to program

running state; at parameter setting (or program setting) ,long press button ④ more than 3 seconds parameter setting(or program setting) , return to factory default setting; At power on (anti-freezing mode OFF) long press button ④ more than 3 seconds, launch coding program, when the receiver is under coding state, so code, or keep original code.

- ⑤ Reset button; the date return to Sunday 0 o'clock, program running mode, all setting is unaltered.
- ⑥ Add button
- ⑦ Shorten button

**Display instruction:**

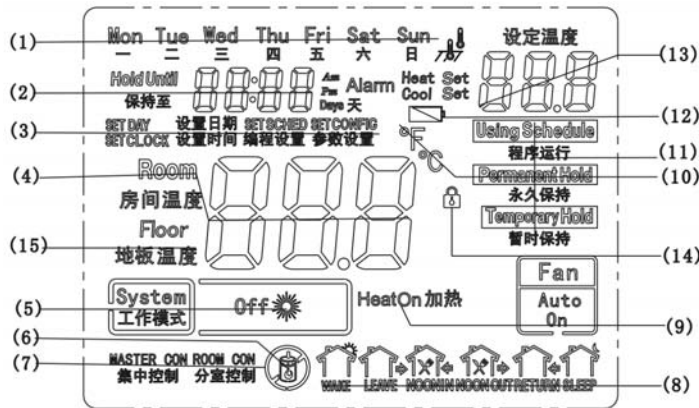

(1) week shows; (2)time shows; (3)setting shows; (4)room shows; (5) mode shows; (6) communication alarm shows; (7) control mode shows; (8)program time shows; (9)starting heating shows ; (10)temperature shows ; (11)operation mode shows; (12) Low battery indicator shows ; ( 13 ) Shows setting temperature; (14)locking key shows (15) floor temperature shows or alarm shows

**INSTALL THE THERMOSTAT**

**Install Battery**

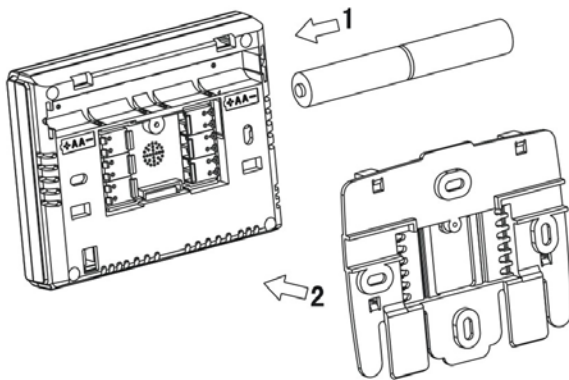

**Wall installation:**

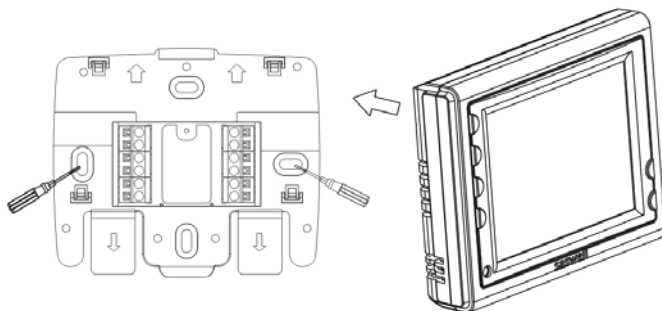

**Tabletop installation:**

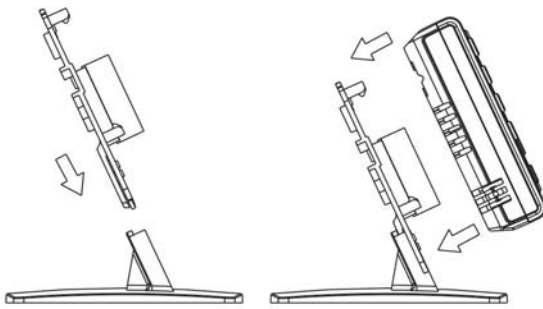

---

**Error and Alarm function**

- 1) “” warning flashes on the screen for approximately 30 days when your thermostat runs out of batteries. Replace the batteries when Low battery warning flashes
- 2) Room Temp (inside room Sensor) broken or short cut, the thermostat will have “room ERR” display
- 3) **Communication alarm:** When the thermostat stops or starts the output, the receiver do not start or not receive some signals that can not return to the thermostat, display will show Er2

---

**OUTPUT REGULATION**

Press  to shift standby or running mode



Standby mode (OFF mode): The system has no output or Temperature lower than the low limitation (LO) alarm,

Running mode (heating mode):

1. Room sensor circuit broken or short cut, heating output stop.
2. Setting Temp – Room Temp  $\geq 1^{\circ}\text{C}$ , heating output on (Fast heating or slow heating, see configuration menu 6 items)
3. Room Temp – Setting Temp  $\geq 1^{\circ}\text{C}$ , heating output off,





---

**Configuration setting**

In standby mode press ③ button under the above three seconds, Through the  ,  button adjustment, After adjustment according to the ④ buttons preservation.

Step	Press buttons	Displayed (factory default)	Press ▲、▼ to select	Descriptions
1	Press P Button	CL(0)	-4 --- +4	Select temperature display adjustment higher or lower
2	Press P Button	RM (350)	20°C (68°F) — 35°C (95°F)	Select maximum room temperature limitation
3	Press P Button	RL (50)	5°C (41°F) — 20°C (68°F)	Select minimum room temperature limitation
4	Press P Button	FL (C)	C/F	Changes the display readout to Centigrade or Fahrenheit as required
5	Press P Button	BL (05)	00/05/15	Backlight mode 00: no backlight 05: backlight maintain 5 sec 15: backlight maintain 15 sec
6	Press P Button	db (10)	05~30	Start heating conditions: when setting temperature < room temperature from the heat, when setting temperature ≥ room temperature reduction db parameters start heating
7	Press P Button	PS 1(7)	0/2/3/7	Program option 7: 7 days separately (Refer table 1 and table 2); 3: 5+1+1 (Refer to table 3 and table 4) 2: 5+2 (Refer to table 5 and table 6) 0: Non programmable
8	Press P Button	PS2(6)	4/6	Programming period in one day option 6-6 time zones; 4-4 time zones;
9	Press P Button	SC (24)	12/24	Time scale 24: 24hour system; 12: 12hour system
10	Press P Button	ES( OFF)	On/OFF	Intelligent Recovery Option OFF : Without intelligent function On:Active intelligent function
11	Press P Button	LR(En)	En/Ch	Language Chinese/English.Factory default: English.



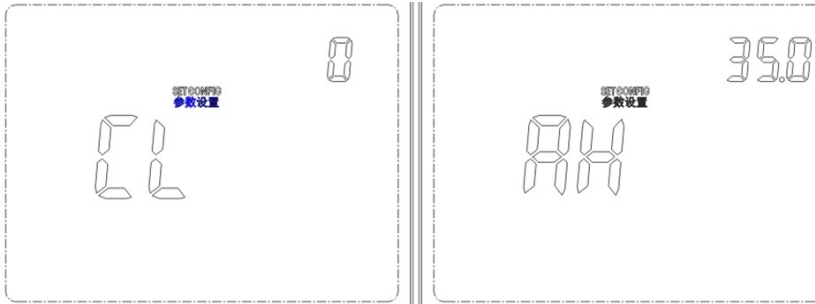

## 2.display for implied parameters:



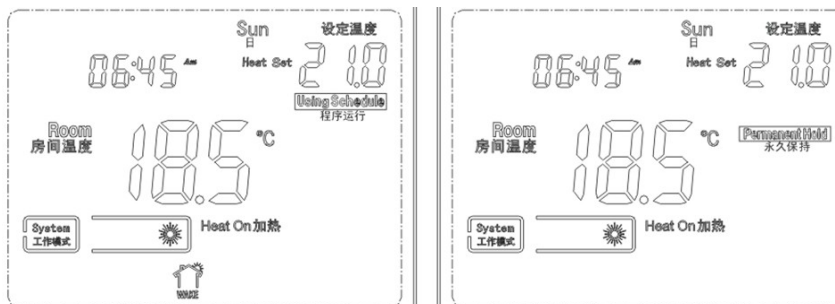

In standby mode, shortly press button  to start; Shortly hold  enter modify the time; Long press  more than 3seconds, enter implied parameters setting; the first item, setting the temperature coefficient: Press  、  change set temperature, short press button **P** enter implied parameters, setting other parameters, when long press button **R** more than 3 seconds, show that DEF flash 3 times, all parameters setting return to factory default setting and return to implied parameters setting the first item, shortly press button **R** exit implied parameters setting and return to OFF mode; In standby mode implied parameters display:







### 3. In boot mode display:



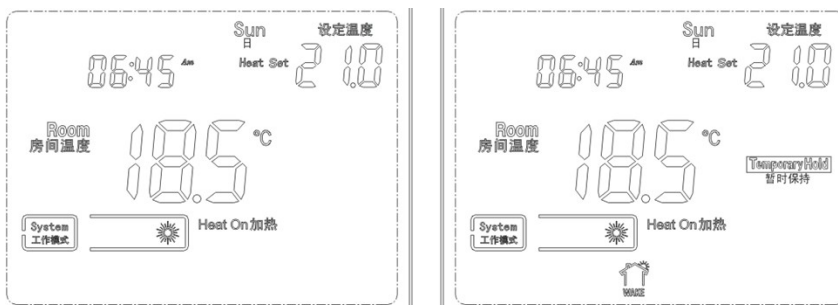



A) In program running mode, shortly press button  enter off mode; shortly press  enter modify the time; shortly press button **P** enter programming state; Long press button **P** more than 3 seconds enter forever keeping mode; shortly press  、  enter temporarily keeping mode

B) In forever keeping mode, shortly press  enter off mode and exit forever keeping mode; shortly press button  enter modify the time; shortly press button **P** enter programming state and exit forever keeping mode; shortly press button **R** exit forever keeping mode; shortly press  、  modify the setting temperature



C) without programming mode running: shortly press  enter off mode; shortly press button  enter modify the time; shortly press  、  modify the setting temperature.

D) In temporarily keeping mode, shortly press  enter off mode and exit temporarily keeping mode; shortly press button  enter modify the time; shortly press button **P** enter programming state and exit temporarily keeping mode; shortly press button **R** exit temporarily keeping mode; long press button **R** enter forever keeping mode; shortly press button  、  modify the setting temperature.

## 2. Programming Setting Instruction



In programming setting mode, look at the factory preprogrammed times and temperatures shown in the sample schedule. If this program will suit your needs, simply press the ③ button to begin running the factory preset program.

If you want to change the preprogrammed time and temperature, follow these steps. Determine the times period and temperature for your program. You can program six/four periods for each day/5+2/5+1+1(See configuration menu item 11).You can choose heating temperature and start time independently. (for example, you may select 5:00 AM and 21°C as the weekday 1<sup>st</sup> period heating start time and temperature and also choose 7:00 AM and 16.5°C and the weekday 1<sup>st</sup> period cooling start time and temperature)

Short press button ③ during the running status , enter the programming surface . you could shift from date setting , time setting ,Temp setting by press button ③ one by one, press ▲ or ▼ to select setting you want. Press ④ quit. . In the programming surface , push ④ button in a same time for 3 seconds. Display will show “DEF” blinking 3 times and return to programming setting 1 indicates all the setting has reverted to factory default setting. Thermostat controls the heating system by presetting program.

Use the tables to plan your program time periods and the temperatures you want during each period. Fill in the complete table to have a record of your program.

Table One ( 7 days 4 Zones Program )

——could revised according to your request





Heating Mode	Morning Get up 		Our for work 		Came back 		Sleep 	
	Time	Temp	Time	Temp	Time	Temp	Time	Temp
Monday Values	6:00	21°C	8:00	16.5°C	18: 00	21°C	22: 00	16.5°C
Tuesday Values	6:00	21°C	8:00	16.5°C	18: 00	21°C	22: 00	16.5°C
Wednesday Values	6:00	21°C	8:00	16.5°C	18: 00	21°C	22: 00	16.5°C
Thursday Values	6:00	21°C	8:00	16.5°C	18: 00	21°C	22: 00	16.5°C
Friday Values	6:00	21°C	8:00	16.5°C	18: 00	21°C	22: 00	16.5°C
Saturday Values	6:00	21°C	8:00	16.5°C	18: 00	21°C	22: 00	16.5°C
Sunday Values	6:00	21°C	8:00	16.5°C	18: 00	21°C	22: 00	16.5°C

Table Two ( 7 days 6 Zones Program )

——could revised according to your request















Heating Mode	Morning Get up 		Our for work 		Lunch 		Noon shift 		Came back 		Sleep 	
	Monday Values	6:00	21°C	8:00	16.5°C	12:00	21°C	14:00	16.5°C	18: 00	21°C	22: 00
Tuesday Values	6:00	21°C	8:00	16.5°C	12:00	21°C	14:00	16.5°C	18: 00	21°C	22: 00	16.5°C
Wednesday Values	6:00	21°C	8:00	16.5°C	12:00	21°C	14:00	16.5°C	18: 00	21°C	22: 00	16.5°C
Thursday Values	6:00	21°C	8:00	16.5°C	12:00	21°C	14:00	16.5°C	18: 00	21°C	22: 00	16.5°C
Friday Values	6:00	21°C	8:00	16.5°C	12:00	21°C	14:00	16.5°C	18: 00	21°C	22: 00	16.5°C
Saturday Values	6:00	21°C	8:00	16.5°C	12:00	21°C	14:00	16.5°C	18: 00	21°C	22: 00	16.5°C
Sunday Values	6:00	21°C	8:00	16.5°C	12:00	21°C	14:00	16.5°C	18: 00	21°C	22: 00	16.5°C

Table Three (5+1+1 4 Zones program)

—————could revised according to your request

Heating Mode	Morning Get up 		Our for work 		Came back 		Sleep 	
	Monday Values	6:00	21°C	8:00	16.5°C	18: 00	21°C	22: 00
Tuesday Values	6:00	21°C	8:00	16.5°C	18: 00	21°C	22: 00	16.5°C
Wednesday Values	6:00	21°C	8:00	16.5°C	18: 00	21°C	22: 00	16.5°C
Thursday Values	6:00	21°C	8:00	16.5°C	18: 00	21°C	22: 00	16.5°C
Friday Values	6:00	21°C	8:00	16.5°C	18: 00	21°C	22: 00	16.5°C

—————could revised according to your request

Heating Mode	Morning Get up 		Our for work 		Came back 		Sleep 	
	Saturday Values	6:00	21°C	8:00	16.5°C	18: 00	21°C	22: 00

—————could revised according to your request

















Heating Mode	Morning Get up		Our for work		Came back		Sleep	
								
Sunday Values	6:00	21°C	8:00	16.5°C	18: 00	21°C	22: 00	16.5°C

Table Four (5+1+1 6 Zones programme) .

—————could revised according to your request

Heating Mode	Morning Get up		Our for work		Lunch		Noon shift		Came back		Sleep	
												
Monday Values	6:00	21°C	8:00	16.5°C	12:00	21°C	14:00	16.5°C	18: 00	21°C	22: 00	16.5°C
Tuesday Values	6:00	21°C	8:00	16.5°C	12:00	21°C	14:00	16.5°C	18: 00	21°C	22: 00	16.5°C
Wednesday Values	6:00	21°C	8:00	16.5°C	12:00	21°C	14:00	16.5°C	18: 00	21°C	22: 00	16.5°C
Thursday Values	6:00	21°C	8:00	16.5°C	12:00	21°C	14:00	16.5°C	18: 00	21°C	22: 00	16.5°C
Friday Values	6:00	21°C	8:00	16.5°C	12:00	21°C	14:00	16.5°C	18: 00	21°C	22: 00	16.5°C

—————could revised according to your request

Heating Mode	Morning Get up		Our for work		Lunch		Noon shift		Came back		Sleep	
												
Saturday Values	6:00	21°C	8:00	16.5°C	12:00	21°C	14:00	16.5°C	18: 00	21°C	22: 00	16.5°C

—————could revised according to your request











Heating Mode	Morning Get up		Our for work		Lunch		Noon shift		Came back		Sleep	
												
Sunday Values	6:00	21°C	8:00	16.5°C	12:00	21°C	14:00	16.5°C	18: 00	21°C	22: 00	16.5°C

Table Five (5+2 4 Zones program) .

—————could revised according to your request

Heating Mode	Morning Get up		Our for work		Came back		Sleep	
								



Monday	6:00	21°C	8:00	16.5°C	18: 00	21°C	22: 00	16.5°C
Values								
Tuesday	6:00	21°C	8:00	16.5°C	18: 00	21°C	22: 00	16.5°C
Values								
Wednesday	6:00	21°C	8:00	16.5°C	18: 00	21°C	22: 00	16.5°C
Values								
Thursday	6:00	21°C	8:00	16.5°C	18: 00	21°C	22: 00	16.5°C
Values								
Friday	6:00	21°C	8:00	16.5°C	18: 00	21°C	22: 00	16.5°C
Values								

——could revised according to your request

















Heating Mode	Morning Get up 		Our for work 		Came back 		Sleep 	
Saturday	6:00	21°C	8:00	16.5°C	18: 00	21°C	22: 00	16.5°C
Values								
Sunday	6:00	21°C	8:00	16.5°C	18: 00	21°C	22: 00	16.5°C
Values								

Table Six (5+2 6 Zones programme)

. ——could revised according to your request

Heating Mode	Morning Get up 		Our for work 		Lunch 		Noon shift 		Came back 		Sleep 	
Monday	6:00	21°C	8:00	16.5°C	12:00	21°C	14:00	16.5°C	18: 00	21°C	22: 00	16.5°C
Values												
Tuesday	6:00	21°C	8:00	16.5°C	12:00	21°C	14:00	16.5°C	18: 00	21°C	22: 00	16.5°C
Values												
Wednesday	6:00	21°C	8:00	16.5°C	12:00	21°C	14:00	16.5°C	18: 00	21°C	22: 00	16.5°C
Values												
Thursday	6:00	21°C	8:00	16.5°C	12:00	21°C	14:00	16.5°C	18: 00	21°C	22: 00	16.5°C
Values												

——could revised according to your request

Heating Mode	Morning Get up 		Our for work 		Lunch 		Noon shift 		Came back 		Sleep 	
Saturday	6:00	21°C	8:00	16.5°C	12:00	21°C	14:00	16.5°C	18: 00	21°C	22: 00	16.5°C
Values												
Sunday	6:00	21°C	8:00	16.5°C	12:00	21°C	14:00	16.5°C	18: 00	21°C	22: 00	16.5°C
Values												

**1. Temporary hold mode**



In normal operation, press ▲ or ▼, “temporary hold” is flashing indicates thermostat is in temporary hold mode. Press ▲ or ▼ to change set temperature, the thermostat will override the current programming setting and keep the room temperature at the selected temperature until the next program period begins. Then the thermostat will automatically revert to the program operation. Press ④ quit .If no keys are pressed within 20 seconds, the thermostat will revert to using schedule.

## 2. Permanent hold temperature setting

When thermostat is in program operation, press button ① over 3 seconds to enter the Permanent hold mode . Press ▲、▼ change set temperature. The thermostat will permanent hold the room temperature at the selected setting until you press ④ button to restart the program operation.

## 3. Code match and Wireless Control:

- 1) According to the system requirements CC2010DE connected to the power source (L, N 100 ~ 240 vac), Check and energizing, Press the power button switch machine is normal or not electricity, light is lit. Otherwise, Please replace the product, Then press the last step action to execute.
- 2) Open CC908XWHB-7-DF1 backplane Load two batteries (AA) , Closed the backplane, And check the display and button functions, not normal replacement product, Press re-execute the previous step action.
- (3) Energized normal CC2010DE products in shutdown mode (indicator), press and hold the power button until the indicator A long bright yellow release, this time CC2010DE in the code state.
- (4) The thermostat CC908XWHB -7- DF1 in standby mode, long according to the thermostat **R** button more than 3 seconds, Emission to code command.
- (5) The success of the code receiving portion yellow flashing 01 blinks four times, Otherwise the code is unsuccessful, Return reflector of the original code value.

Note: When in the process for the debug on/off, the interval of time should more than 4 sec, otherwise the products have not time for react.

## 4. Reset operation

If the display is abnormal, press the Reset button by using a fine probe such as a straightened paper clip to gently push the Rest button. This will reset the thermostat.

5. **Battery note:** 1)The battery power low battery warning sign "" flicker  
2) Products when not in use for a long time, please take off, to prevent battery leakage damage product



## **CUSTOMER ASSISTANCE**

After reading this guide, if you have any question about the operation of your thermostat, please contact your installer or service provider.

